

Specifications for Approval

Customer Part No.:

JOINHANDS Part No.: JH-CMRGG19GTP034

Part Name: 3010 红绿共阴 LED

Spec Issue Date:2019-01-09

Revision No.: A0

=====

To Customer:

1. Accessory: Samples Samples Data
2. Customer's Proposal : Agree Disagree

Reason :

Draw by :	Checked by :	Approved by :
李飞	卢伟昌	钟志鸿
Customer Approve		



广东晶瀚光电科技有限公司
GUANGDONG JOINHANDS Optoelectronics Technology Co.,Ltd
地址:东莞市寮步镇塘边社区华南工业城金富路 13 号
鼎昊自动化孵化园 2 区 B 栋 101 号
Tel:0769-82233086 Fax:0769-82233606
<http://www.joinhands-cn.com>
E-mail: hanser.yu@joinhands-cn.com

Features

3.0mm X 1.0mm SMD LED, 1.4mm thickness

Low power consumption

Wide view angle

Package: 3000pcs/reel

RoHS Compliant

Applications

Ideal for back light and indicator

Various colors and lens types available

Package outlines

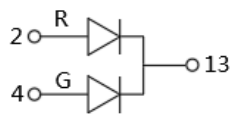
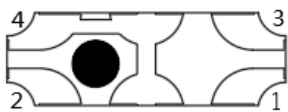
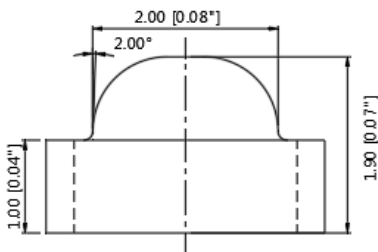
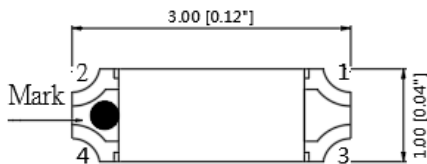

Recommend Pad Layout

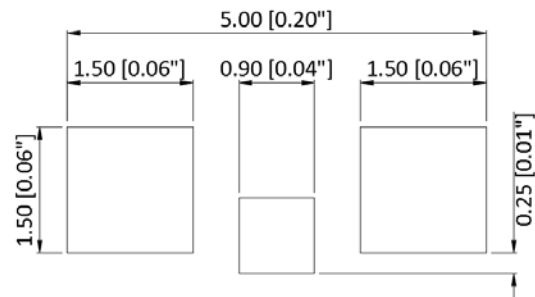

Part No.	Emitted color	Dice	Lens color
JH-CMRGG19GTJ034	Red	AlGaInP	Water transparent
	Green	InGaN/GaN	

Notes:

- All dimensions are in millimeters (inches);
- Tolerances are $\pm 0.1\text{mm}$ (0.004inch) unless otherwise noted.

Absolute Maximum Ratings (Ta=25°C)

Parameter	Symbol	Value		Unit
		R	G	
Forward current	If	30		mA
Reverse voltage	Vr	5		V
Power dissipation	Pd	72	111	mW
Operating temperature	Top	-40 ~+85		°C
ESD(Human-body mode)	--	4	2	KV
Storage temperature	Tstg	-40 ~+85		°C
Peak pulsing current (1/8 duty f=1kHz)	Ifp	125		mA

Electro-Optical Characteristics (Ta=25°C)

Parameter	Test Condition	Symbol	Value			Unit
			Min	Typ	Max	
Wavelength at peak emission	If=20mA	R	--	630	--	nm
		λ_{pG}	--	540	--	
Spectral half bandwidth	If=20mA	R	--	20	--	nm
		$\Delta\lambda_G$	--	25	--	
Dominant wavelength	If=20mA	R	620	--	630	nm
		λ_{dG}	520	--	530	
Forward voltage	If=20mA	R	1.8	--	2.4	V
		VfG	2.8	--	3.7	
Luminous intensity	If=20mA	R	100	250	320	mcd
		IV G	320	560	800	
Viewing angle at 50% Iv	If=10mA	2 θ 1/2	--	120	--	Deg
Reverse current	Vr=5V	Ir	--	--	10	μ A

Relative Spectral Emission (Red)

IF=20mA, Ta=25°C

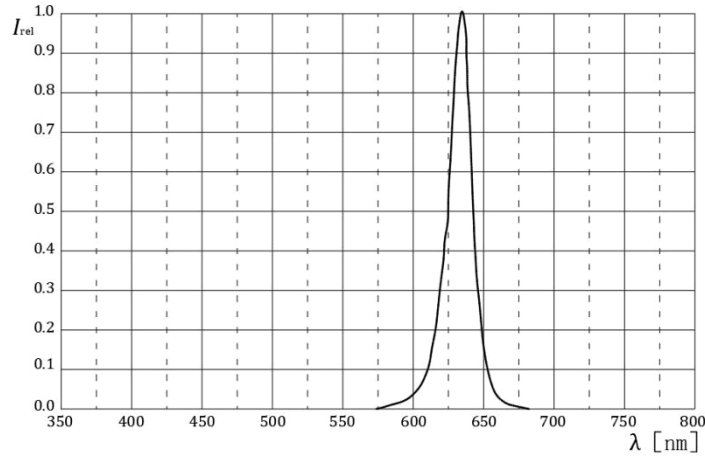

Radiation Characteristics

IF=10mA, Ta=25°C

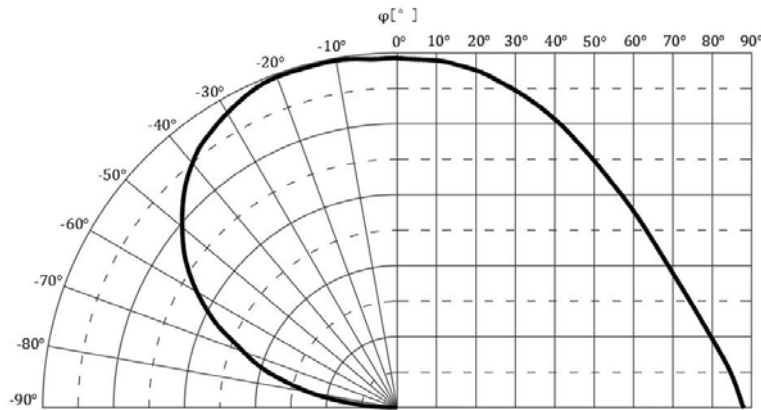

Forward Current vs Forward Voltage Forward Current Derating Curve

Ta=25°C

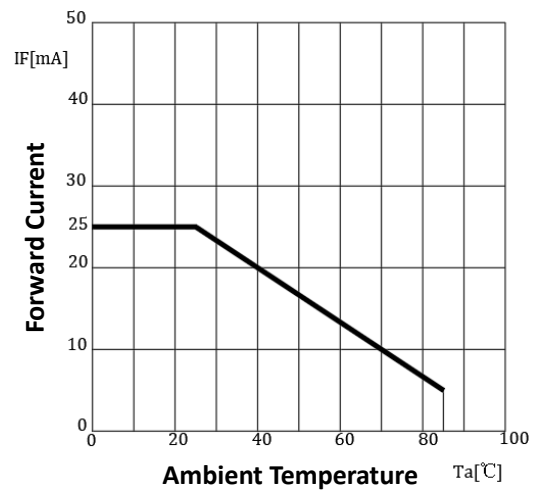
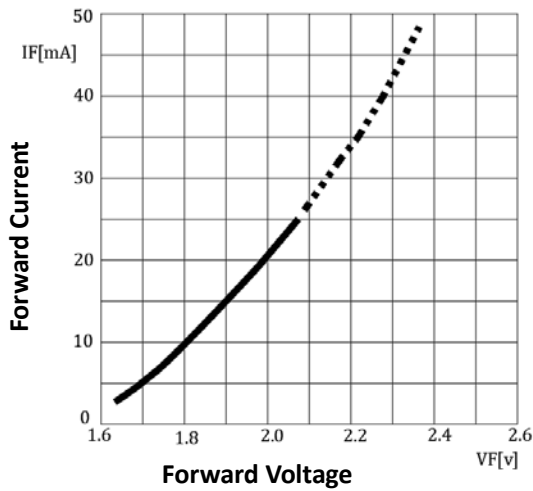

Relative Spectral Emission (Green)

IF=20mA, Ta=25°C

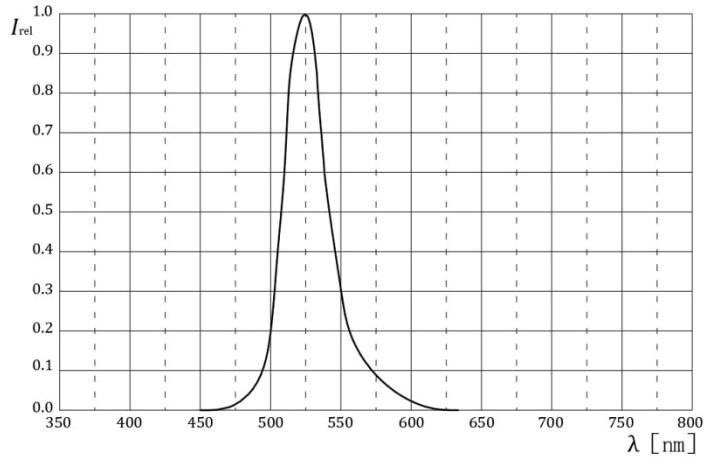

Radiation Characteristics

IF=10mA, Ta=25°C

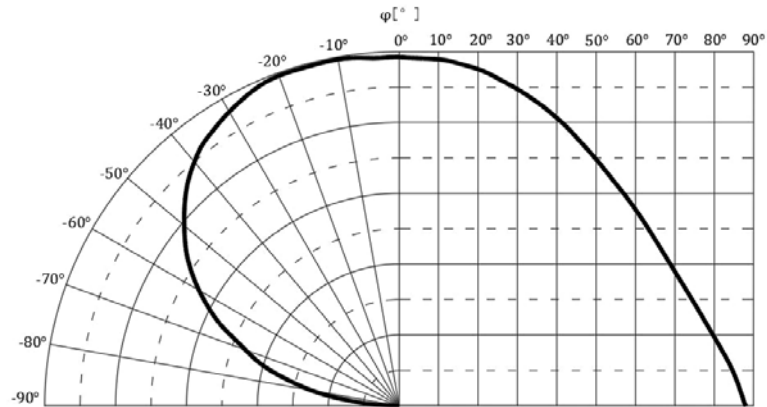

Forward Current vs Forward Voltage Forward Current Derating Curve

Ta=25°C

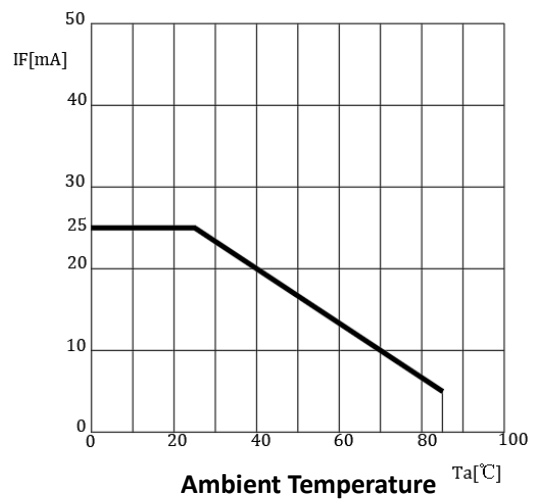
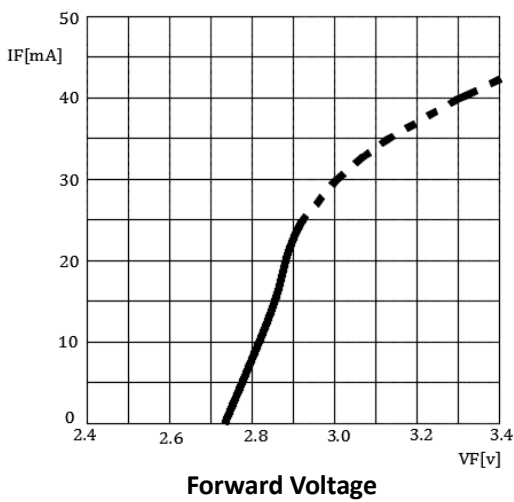

Reflow Profile

■ Reflow Temp/Time

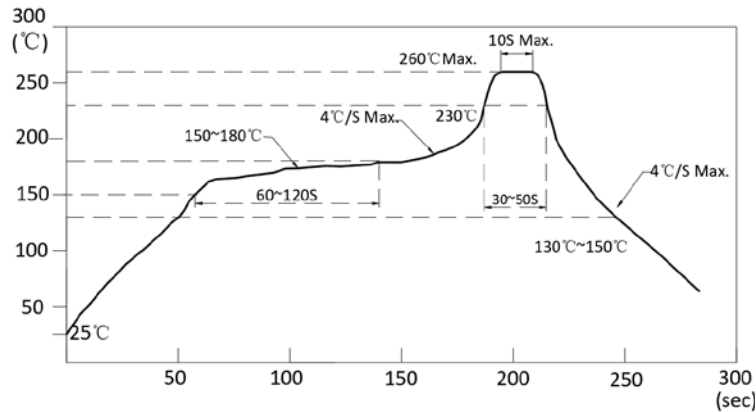

Notes:

1. We recommend the reflow temperature 245°C(±5°C).The maximum soldering temperature should be limited to 260°C.
2. Don't cause stress to the epoxy resin while it is exposed to high temperature.
3. Number of reflow process shall be 2 times or less.

■ Soldering iron

Basic spec is ≤ 5sec when 320°C(±20°C). If temperature is higher, time should be shorter(+10°C → -1sec). Powerdissipation of iron should be smaller than 20W, and temperatures should be controllable. Surface temperature of the device should be under 350°C.

■ Rework

1. Customer must finish rework within 5 sec under 340°C.
2. The head of iron cannot touch copper foil
3. Twin-head type is preferred.

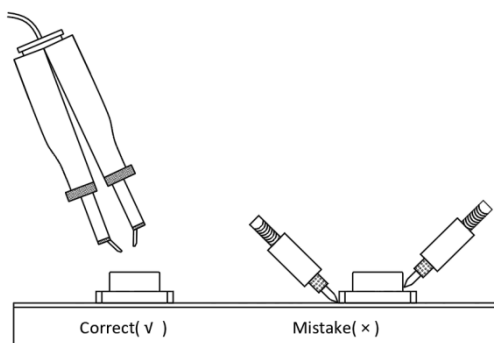

- Avoid rubbing or scraping the resin by any object, during high temperature, for example reflow solder etc.

Handling precautions

1. Drive Method

A LED is a current-operated device. In order to ensure intensity uniformity on multiple LEDs connected in parallel in an application, it is recommended that a current limiting resistor be incorporated in the drive circuit, in series with each LED as shown in Circuit below.

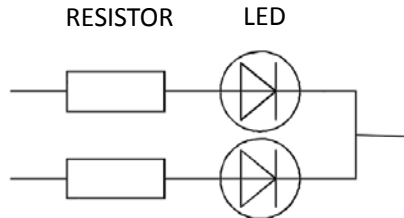

2. Storage

- 2.1 Do not open moisture proof bag before the products are ready to use.
- 2.2 Before opening the package: The LEDs should be kept at 30°C or less and 60% RH or less.
- 2.3 After the package is opened, the products should be used within a week or they should be kept to store at $\leq 20^{\circ}\text{C}$ with zip

3. Baking

It is recommended to baking before soldering when the pack is unsealed after 72hrs. The Conditions are as followings:

- 3.1 $60\pm 3^{\circ}\text{C}$ x(12~24hrs) and $< 5\% \text{RH}$, taped reel type
- 3.2 $100\pm 3^{\circ}\text{C}$ x(45min~1hr), bulk type
- 3.3 $130\pm 3^{\circ}\text{C}$ x(15~30min), bulk type

Test Items and Results of Reliability

Test Item	Test Conditions	Standard Test Method	Note	Number of Test
Reflow Soldering	Ta=260±5℃,Time=10±2S	JB/T 10845-2008	3times	0/22
Salt Atmosphere	Ta=35±3℃,PH=6.5~7.2	GB/T 2423.17-2008	24hrs	0/22
Temperature Cycling	-40±5℃ 30±1min ↑→(25℃/5±1min)↓ 100±5℃ 30±1min	GB/T 2423.22-2012	100cycles	0/22
Thermal Shock	Ta=-40±5℃~100±5℃, 15±1min dwell	GB/T 2423.22-2012	100cycles	0/22
High Humidity High Temp. Cycling	Ta=30±5℃~65±5℃, 90±5%RH,24hrs/1cycle	GB/T 2423.4-2008	10cycles	0/22
High Humidity High Temp. Storage Life	Ta=85±5℃,ψ(%)=85±5%RH	GB/T 2423.3-2006	1000hrs	0/22
High Temperature Storage Life	Ta=100±5℃,non-operating	GB/T 2423.2-2008	1000hrs	0/22
Low Temperature Storage Life	Ta=-40±5℃,non-operating	GB/T 2423.1-2008	1000hrs	0/22
Life Test	Ta=26±5℃,@20mA, ψ(%)=25%RH~55%RH	--	1000hrs	0/22
High Humidity High Temp. Operating Life	Ta=85±5℃,@20mA, ψ(%)=85%RH	GB/T 2423.3-2006	500hrs	0/22
Low Temperature Operating Life	Ta=-20±5℃,@20mA	GB/T 2423.1-2008	1000hrs	0/22

Forward Voltage Rank Combination (IF=20mA)

Rank		Min.	Max.	Unit
Red	□	1.8	2.4	V
Green	f	2.8	3.1	
	g	3.1	3.4	
	h	3.4	3.7	

Luminous Intensity Rank Combination (IF=20mA)

Rank		Min.	Max.	Unit
Red	J	100	125	mcd
	K	125	160	
	L	160	200	
	M	200	250	
	N	250	320	
Green	O	320	400	
	P	400	500	
	Q	500	630	
	R	630	800	

Dominant wavelength Rank Combination (IF=20mA)

Rank		Min.	Max.	Unit
Red	t	620	625	nm
	u	625	630	
Green	U	520	522.5	
	V	522.5	525	
	W	525	527.5	
	X	527.5	530	

Group Name on Label (Example DATA: □KtfQU 20)

DATA: □KtfQU 20		Vf(V)	Iv (mcd)	λd (nm)	Test Condition
Red	□→K→t→20	1.8~2.4	125~160	620~625	IF=20mA
Green	f→Q→U→20	2.8~3.1	500~630	520~522.5	

Notes:

1. The tolerance of luminous intensity (Iv)is $\pm 15\%$.
2. The tolerance of dominant wavelength is $\pm 1\text{nm}$.
3. This specification is preliminary.
4. This specification is a standard specification of our factory, can make in accordance with customer's special requirement.

3010 Series SMD Chip LED Lamps Packaging Specifications

● **Feeding Direction**

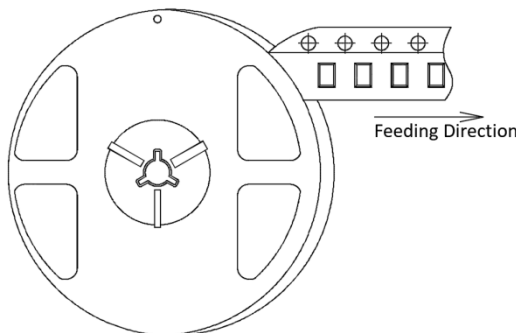

● **Dimensions of Reel (Unit: mm)**

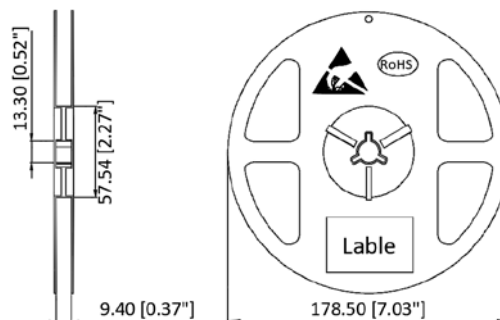

● **Dimensions of Tape (Unit: mm)**

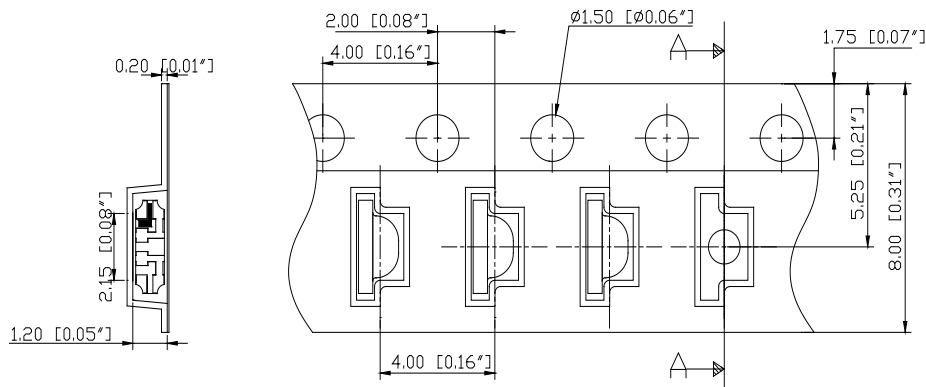

● **Arrangement of Tape**

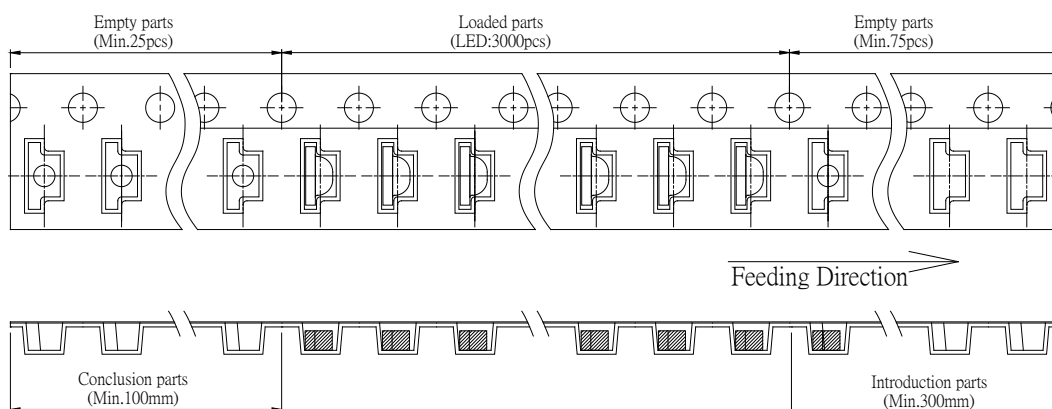

Notes:

1. Empty component pockets are sealed with top cover tape;
2. The maximum number of missing lamps is two;
3. The cathode is oriented towards the tape sprocket hole in accordance with ANSI/EIA RS-481 specifications.

4. 3,000pcs/Reel.

3010 Series SMD Chip LED Lamps Packaging Specifications

- **Label Explanation**



CPN:Customer's Product Number
 P/N:Product Number
 QTY:Packing Quantity
 LOT NO:Lot Number
 VF:Forward Voltage Rank
 IV:Luminous Intensity Rank
 WLD:Dom. Wavelength Rank
 BIN:BIN Code
 DATE:Date Of Dispatch

- **Transportation Packing**

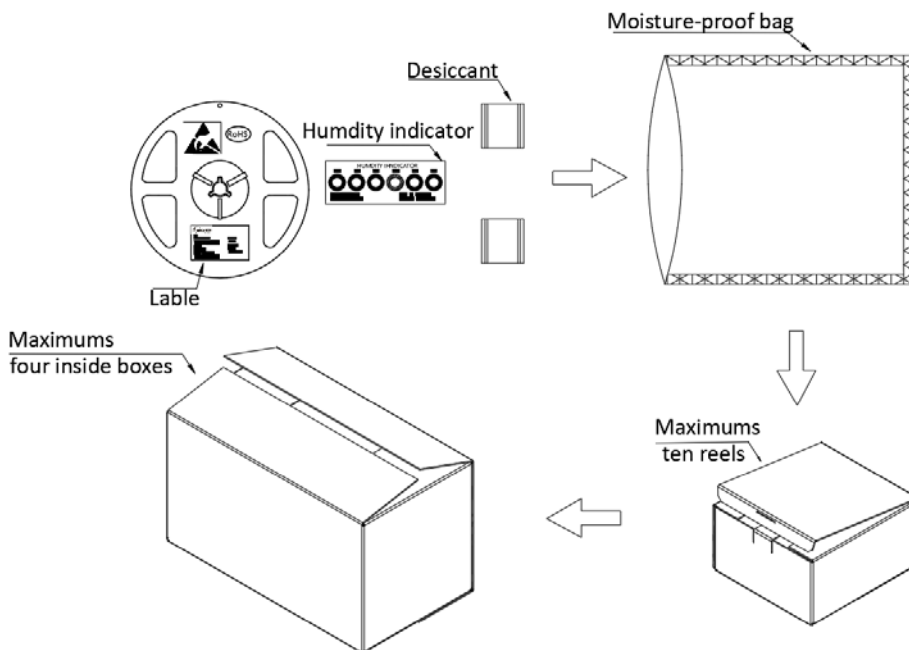

Notes:

Reeled products (numbers of products are 3,000pcs) packed in a seal off moisture-proof bag along with two desiccant one by one, ten moisture-proof bag of maximums packed in an inside box (about size: 240x 220x 120mm) and four inside boxes of maximums are put in the outside box (about size: 460mm x 246mm x 250mm) Together with buffer material, and it is packed. The number of the loading steps of outsidebox (cardboard box) has it to three steps.